



# Grass Trimmer/Brush Cutter

## *Operator's Manual*

**MODELS, Type 1E SRM - 2100, 2110**  
Serial Number 982333 & Up

**WARNING  DANGER**



The muffler or catalytic muffler and surrounding cover may become extremely hot.

Always keep clear of exhaust and muffler area, otherwise serious personal injury may occur.

** WARNING **

The engine exhaust from this product contains chemicals known to the State of California to cause cancer, birth defects or other reproductive harm.



**WARNING  DANGER**

Read rules for safe operation and instructions carefully. ECHO provides an Operator's Manual and a Safety Manual. Both must be read and understood for proper and safe operation.

## INTRODUCTION

Welcome to the ECHO family. This ECHO product was designed and manufactured to provide long life and on-the-job dependability. Read and understand this manual and the SAFETY MANUAL you found in the same package. You will find both easy to use and full of helpful operating tips and SAFETY messages.

### THE OPERATOR'S MANUAL

Read and understand this manual before operation. Keep it in a safe place for future reference. It contains specifications and information for operation, starting, stopping, maintenance, storage and assembly specific to this product.

### THE SAFETY MANUAL

Read and understand this manual before operation. Keep it in a safe place for future reference. It explains possible hazards involved with the use of Grass Trimmers and Brush Cutters and what measures you should take to make their use safer.

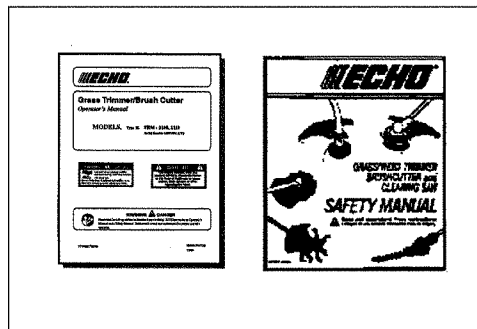

## TABLE OF CONTENTS

|   |     |   |     |
|---|-----|---|-----|
| Introduction .....                                    | 2   | Operation .....                           | 21  |
| - The Operator's Manual .....                         | 2   | - Starting Cold Engine .....              | 21  |
| - The Safety manual .....                             | 2   | - Starting Warm Engine .....              | 22  |
| Manual Safety Symbols and Important Information ..... | 3   | - Stopping Engine .....                   | 22  |
| Safety .....  | 3   | Maintenance .....                         | 23  |
| - Decals .....  | 3   | - Skill Levels .....                      | 23  |
| - International Symbols .....                         | 4   | - Maintenance Intervals .....             | 23  |
| Safety Instructions .....                             | 5   | - Air Filter .....                        | 24  |
| - Personal Condition and Safety Equipment .....       | 5   | - Fuel Filter .....                       | 24  |
| - Extended Operation/Extreme Conditions .....         | 5   | - Spark Plug .....                        | 25  |
| - Equipment .....                                     | 6   | - Cooling System Cleaning .....           | 25  |
| - Safe Operation .....                                | 7   | - Exhaust System .....                    | 26  |
| Emission Control .....                                | 7*  | - Carburetor Adjustment .....             | 27* |
| Description .....                                     | 7   | - Lubrication .....                       | 28  |
| - Contents .....                                      | 8   | - Nylon Line Replacement .....            | 28  |
| Specifications .....                                  | 11  | - Sharpening Metal Blades .....           | 30  |
| Assembly .....  | 12  | Troubleshooting .....                     | 31  |
| - Plastic Shield Installation .....                   | 12  | Storage .....                             | 32  |
| - Nylon Head Installation .....                       | 12  | Servicing Information .....               | 36  |
| - Blade Installation .....                            | 13  | - Parts .....                             | 36  |
| - Throttle Linkage and Ignition Leads .....           | 15  | - ECHO Consumer Product Service .....     | 36  |
| - Front Handle Installation .....                     | 15  | - Service .....                           | 36  |
| - U-Handle Installation .....                         | 16  | - Warranty Card .....                     | 36  |
| Pre-Operation .....                                   | 18  | - Additional or Replacement Manuals ..... | 36  |
| - Operation with Blades .....                         | 18  | *Page 7 Supplement .....                  | 37  |
| - Fuel .....  | 20* | *Page 20 Supplement .....                 | 37  |
|   |     | *Page 27 Supplement .....                 | 37  |

Specifications, descriptions and illustrative material in this literature are as accurate as known at the time of publication, but are subject to change without notice. Illustrations may include optional equipment and accessories, and may not include all standard equipment.

## MANUAL SAFETY SYMBOLS AND IMPORTANT INFORMATION

Throughout this manual and on the product itself, you will find safety alerts and helpful, information messages preceded by symbols or key words. The following is an explanation of those symbols and key words and what they mean to you.



This symbol accompanied by the words **WARNING** and **DANGER** calls attention to an act or condition that can lead to serious personal injury to operator and bystanders.



The circle with the slash symbol means whatever is shown within the circle is prohibited.



**IMPORTANT** The enclosed message provides information necessary for the protection of the unit.

**NOTE** This enclosed message provides tips for use, care and maintenance of the unit.

## SAFETY

### DECALS

Locate these safety decals on your unit. The complete unit illustration, found in the "DESCRIPTION" section, will help you locate them. Make sure the decals are legible and that you understand and follow the instructions on them. If a decal cannot be read, a new one can be ordered from your ECHO dealer. See PARTS ORDERING instructions for specific information.

### DEBRIS SHIELD DECAL



Plastic Debris Shield



Metal Debris Shield

## Shaft Decal

P/N 89016844830





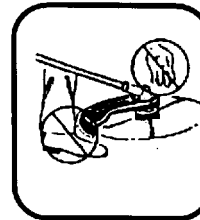
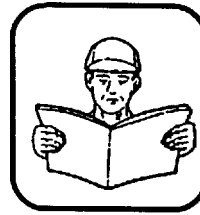

### WARNING DANGER

- This unit can be dangerous and cause serious injury if improperly used. To reduce injury risk to operator, helpers and bystanders, read and understand the Operator's and Safety manuals.
- Blindness can occur from objects that are thrown or ricocheted even with shield in place. Operators, helpers and bystanders must wear ANSI Z87.1 approved eye protection.
- Always wear hearing protection when operating unit.
- Prevent accidental contact with unit and any cutting attachment. Maintain a 50 ft. (15M) radius, **DANGER ZONE** surrounding the operator. **ONLY** the operator, dressed in proper protective clothing should be in the **DANGER ZONE**.
- Beware of **KICKOUT (blade thrust)** when using blades. Special precautions are necessary for blade operation, see your Operator's and Safety Manuals. **ONLY** install ECHO approved blades on Brush Cutters (SRM) models equipped with proper blade shield, U-handles, harness, blade collar, nut and cotter pin.
- Blade/Cutting attachment does not stop immediately after releasing throttle. Keep hands and feet clear of blade/cutting attachment unless engine is shut off and cutting attachment is not moving.
- **INSPECT BLADES BEFORE USE.**
- **DO NOT USE DAMAGED, CRACKED, BENT, DULL OR IMPROPERLY SHARPENED BLADES.**
- Do not remove shields, modify the unit or install attachments or parts not approved by ECHO. Approved attachment information and replacement Operator's and Safety Manuals are available from your ECHO dealer or by writing: **ECHO, INCORPORATED, 400 OAKWOOD RD., LAKE ZURICH, IL 60047.**

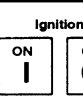

## INTERNATIONAL SYMBOLS

| SYMBOL FORM/ SHAPE  | SYMBOL DESCRIPTION/APPLICATION                  | SYMBOL FORM/ SHAPE  | SYMBOL DESCRIPTION/APPLICATION           |
|---|---|---|--|
|  | "WARNING, SEE OPERATOR'S MANUAL"                |  | HOT SURFACE                              |
|  | WEAR EYES, EARS AND HEAD PROTECTION             |  | FINGER SEVERING                          |
|  | WEAR HAND AND FOOT PROTECTION                   |  | DO NOT ALLOW FLAMES OR SPARKS NEAR FUEL. |
|  | SAFETY/ALERT                                    |  | DO NOT SMOKE NEAR FUEL.                  |
|  | KEEP BYSTANDERS AND HELPERS AWAY 15 M (50 FT.). |   |  |

| SYMBOL FORM/ SHAPE  | SYMBOL DESCRIPTION/APPLICATION             | SYMBOL FORM/ SHAPE  | SYMBOL DESCRIPTION/APPLICATION |
|---|--|---|--------------------------------|
|  | EMERGENCY STOP                             |  | FUEL AND OIL MIXTURE           |
|  | CARBURETOR ADJUSTMENT - HIGH SPEED MIXTURE |  | Primer Bulb                    |
|  | CARBURETOR ADJUSTMENT - IDLE SPEED         |  | Ignition ON/OFF                |
|  | CARBURETOR ADJUSTMENT - LOW SPEED MIXTURE  |  | Engine choke control.          |

## SAFETY INSTRUCTIONS

### PERSONAL CONDITION AND SAFETY EQUIPMENT

#### WARNING DANGER

Trimmer/Brush Cutter users risk injury to themselves and others if the trimmer/brush cutter is used improperly and or safety precautions are not followed. Proper clothing and safety gear must be worn when operating a trimmer.

#### **Physical Condition --**

Your judgment and physical dexterity may not be good:

- if you are tired or sick,
- if you are taking medication,
- if you have taken alcohol or drugs.

Operate unit only if you are physically and mentally well.

#### **Eye Protection --**

Wear eye protection that meets ANSI Z87.1 or CE requirements whenever you operate the trimmer.

#### **Hand Protection --**

Wear no-slip, heavy duty work gloves to improve your grip on the Trimmer/Brush Cutter handles. Gloves also reduce the transmission of machine vibration to your hands.

#### **Hearing Protection --**

ECHO recommends wearing hearing protection whenever unit is used.

#### **Proper Clothing --**

Wear snug fitting, durable clothing;

- Pants should have long legs, shirts with long sleeves.
- **DO NOT WEAR SHORTS,**
- **DO NOT WEAR TIES, SCARVES, JEWELRY.**

Wear sturdy work shoes with non-skid soles;

- **DO NOT WEAR OPENTOED SHOES,**
- **DO NOT OPERATE UNIT BAREFOOTED.**

## EXTENDED OPERATION/EXTREME CONDITIONS

### **Vibration and Cold**

It is believed that a condition called Raynaud's Phenomenon, which affects the fingers of certain individuals may be brought about by exposure to vibration and cold. Exposure to vibration and cold may cause tingling and burning sensations followed by loss of color and numbness in the fingers. The following precautions are strongly recommended because the minimum exposure which might trigger the ailment is unknown.

- Keep your body warm, especially the head, neck, feet, ankles, hands and wrists.
- Maintain good blood circulation by performing vigorous arm exercises during frequent work breaks and also by not smoking.
- Limit the hours of operation. Try to fill each day with jobs where operating the trimmer or other hand-held power equipment is not required.
- If you experience discomfort, redness and swelling of the fingers followed by whitening and loss of feeling, consult your physician before further exposing yourself to cold and vibration.

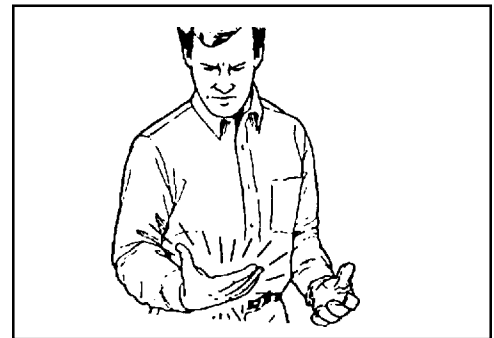

## ***Repetitive Stress Injuries***

It is believed that overusing the muscles and tendons of the fingers, hands, arms and shoulders may cause soreness, swelling, numbness, weakness and extreme pain in those areas. Certain repetitive hand activities may put you at a high risk for developing a Repetitive Stress Injury (RSI). An extreme RSI condition is Carpal Tunnel Syndrome (CTS), which could occur when your wrist swells and squeezes a vital nerve that runs through the area. Some believe that prolonged exposure to vibration may contribute to CTS. CTS can cause severe pain for months or even years.

To reduce the risk of RSI/CTS, do the following:

- Avoid using your wrist in a bent, extended or twisted position. Instead try to maintain a straight wrist position. Also, when grasping, use your whole hand, not just the thumb and index finger.
- Take periodic breaks to minimize repetition and rest your hands.
- Reduce the speed and force with which you do the repetitive movement.
- Do exercises to strengthen the hand and arm muscles.
- Immediately stop using all power equipment and consult a doctor if you feel tingling, numbness or pain in the fingers, hands, wrists or arms. The sooner RSI/CTS is diagnosed, the more likely permanent nerve and muscle damage can be prevented.

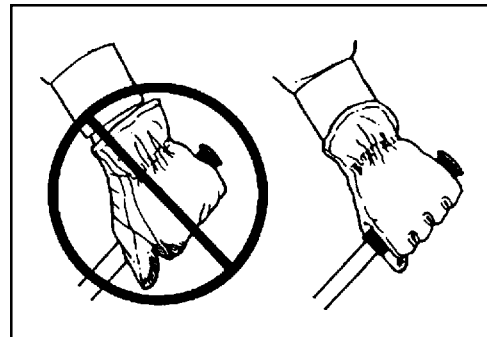

## **EQUIPMENT**

### **WARNING** **DANGER**

Use only ECHO approved attachments. Serious injury may result from the use of a non approved attachment combination. Read and comply with all safety instructions listed in this manual and safety manual. ECHO, INC. will not be responsible for the failure of cutting devices, attachments or accessories which have not been tested and approved by ECHO.

- Check unit for loose/missing nuts, bolts and screws. Tighten and/or replace as needed.
- Inspect fuel lines, tank and area around carburetor for fuel leaks. DO NOT operate unit if leaks are found.
- Inspect shield for damage and ensure that the cut-off knife is securely in place. Replace if either is damaged or missing.
- Check that the cutting attachment is firmly attached and in safe operating condition.
- Check that front (loop) handle and optional shoulder/waist harness are adjusted for safe, comfortable operation. See Assembly for proper adjustment.
- Keep exhaust area clear of flammable debris. Avoid contact during and immediately after operation.

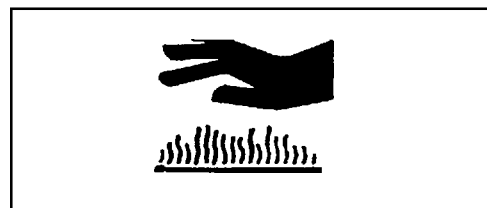

## SAFE OPERATION

### WARNING DANGER

Do not operate this product indoors or in inadequately ventilated areas. Engine exhaust contains poisonous emissions and can cause serious injury or death.

- Provide all operators of this equipment with the Operator's Manual and instructions for safe operation.

#### **Keep A Firm Grip**

- Hold the front and rear handles with both hands with thumbs and fingers encircling the handles

#### **Keep A Solid Stance**

- Maintain footing and balance at all times. Do not stand on slippery, uneven or unstable surfaces. Do not work in odd positions or on ladders. Do not over reach.



## EMISSION CONTROL

The emission control system for these engines are EM (Engine Modification).

**An Emission Control Label** is located on the engine. (This is an EXAMPLE ONLY, information on label varies by engine FAMILY).

#### IMPORTANT ENGINE INFORMATION

ENGINE FAMILY: TEH021UB24RA

DISPLACEMENT: 21.2 CC

THIS ENGINE MEETS U.S. EPA PHASE I EMISSION REGULATIONS FOR SMALL NON ROAD ENGINE. REFER TO OWNER'S MANUAL FOR MAINTENANCE SPECIFICATIONS AND ADJUSTMENTS.



**KIORTZ CORP.**



## DESCRIPTION

The ECHO product you purchased has been factory pre-assembled for your convenience. Due to packaging restrictions, shield installation and other assembly may be necessary.

After opening the carton, check for damage. Immediately notify your retailer or ECHO Dealer of damaged or missing parts. Use the contents list to check for missing parts.

## CONTENTS

| CONTENTS LIST                             |         |         |
|---|---------|---------|
| ITEMS                                     | MODELS  |         |
|   | 2100 1E | 2110 1E |
| 1 - POWERHEAD                             | √       | √       |
| 1 - DRIVE SHAFT ASSEMBLY                  | √       | √       |
| 1 - PLASTIC BAG (CO-PACK)                 | √       | √       |
| - 1, OPERATOR'S MANUAL                    | √       | √       |
| - 1, SAFETY MANUAL                        | √       | √       |
| - 1, WARRANTY REGISTRATION CARD           | √       | √       |
| - 1, LIMITED WARRANTY STATEMENT           | √       | √       |
| - 1, PLASTIC SHIELD                       | √       | √       |
| - 1, PLASTIC SHIELD HARDWARE              | √       | √       |
| --1, SHIELD PLATE                         | √       | √       |
| --3, 5MM X 15MM SCREWS (SHIELD MGT.)      | √       | √       |
| - 1, ASSEMBLY TOOLS                       | √       | √       |
| --1, 8MM X 10MM WRENCH                    | √       | √       |
| --1, SCRENCH                              | √       | √       |
| --1, LOCKING TOOL                         | √       | √       |
| - 1, NYLON TRIMMER HEAD                   | √       | √       |
| - 1, SAFETY GLASSES                       | √       | √       |
| - 1, 2-STROKE OIL SAMPLE, 2.6 OZ.         |         | √       |
| - 1, SHOULDER HARNESS W/HIP PAD           |         | √       |
| - 1, SHOULDER HARNESS W/O HIP PAD         |         | √       |
| -- 1, HARNESS CLAMP                       |         | √       |
| - 1, U-HANDLE HARDWARE                    |         | √       |
| --1, METAL SHIELD                         |         | √       |
| --1, SHIELD BRACKET                       |         | √       |
| - 1, METAL SHIELD HARDWARE                |         | √       |
| --3, 5MM X 15MM SCREWS (SHIELD MOUNT)     |         | √       |
| --2, 5MM X 8MM SCREWS (BRACKET TO SHIELD) |         | √       |
| --4, 5MM NUTS                             |         | √       |
| --4, 5MM LOCKWASHERS                      |         | √       |
| --1, PLASTIC BAG                          |         | √       |
| ---1, 8MM X 55MM SCREW (HANDLE MGT.)      |         | √       |
| ---1, WASHER, CIRCULAR                    |         | √       |
| ---2, CABLE CLIPS                         |         | √       |

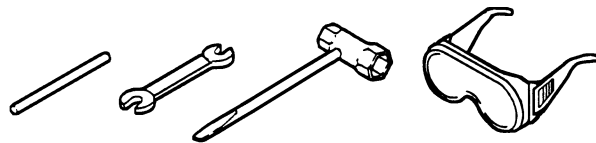
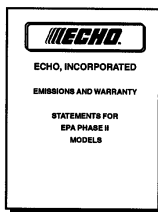
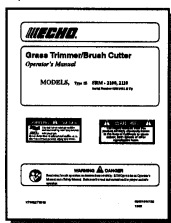



# GRASS TRIMMER/BRUSH CUTTER 9 OPERATOR'S MANUAL

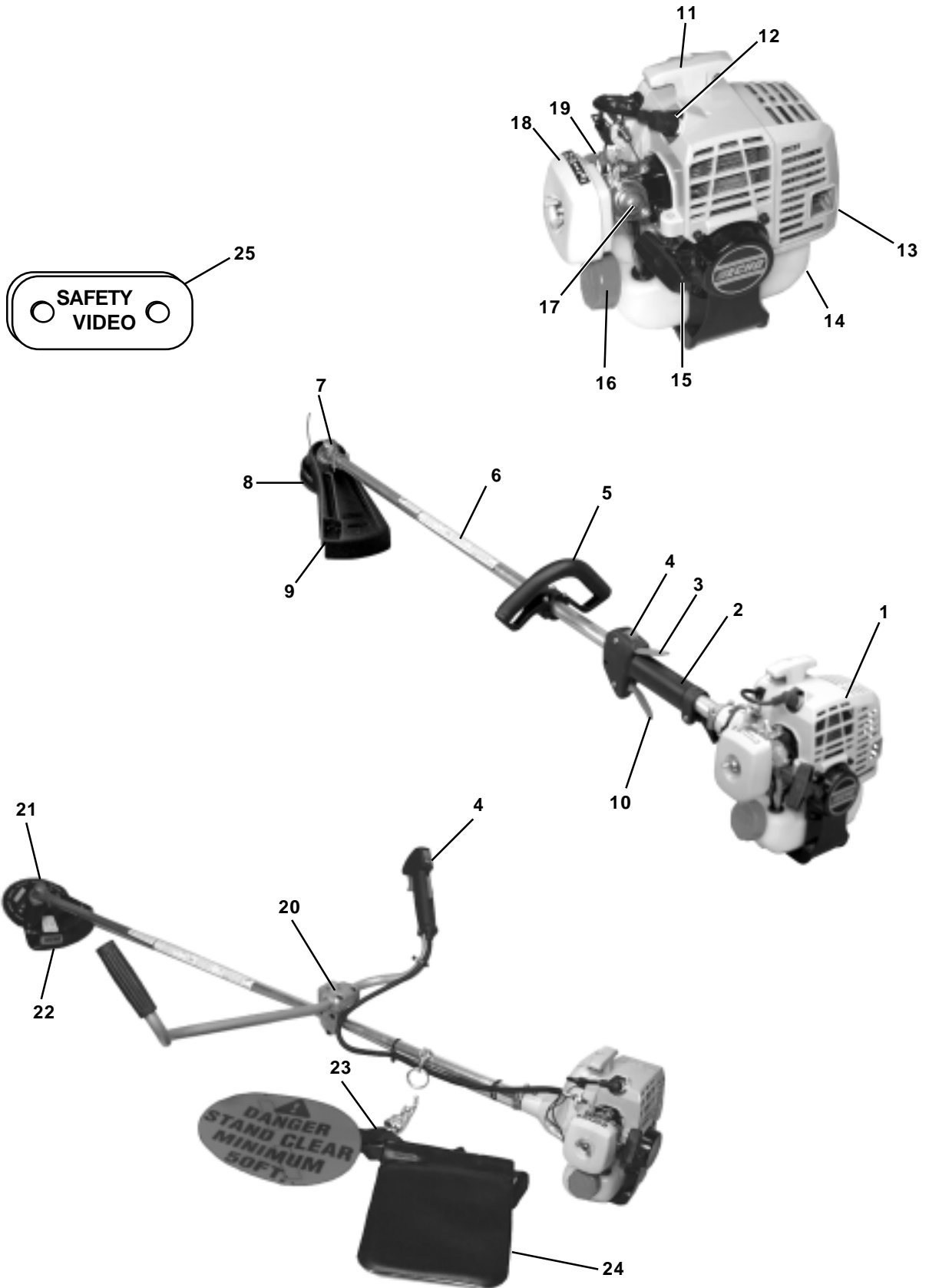

1. **POWER HEAD** - Includes the Engine, Clutch, Fuel System, Ignition System and Recoil Starter.
2. **GRIP** - Rear (right hand) handle.
3. **THROTTLE TRIGGER LOCKOUT** - This lever must be held down during starting. Operation of the throttle trigger is prevented unless throttle trigger lockout lever is depressed.
4. **STOP SWITCH** - "SLIDE SWITCH" mounted on top of the Throttle Trigger Housing. Move switch FORWARD to RUN, BACK to STOP.
5. **FRONT HANDLE** - The front handle is factory assembled to the Drive Shaft assembly (some models) but must be re-positioned for proper cutting attitude and operator comfort.
6. **DRIVE SHAFT ASSEMBLY** - Includes the Rear (right hand) Handle assembly, Gear Housing assembly, Front, (left hand) Handle assembly, Flexible Drive Cable and Safety Decal.
7. **NYLON CUTTING ATTACHMENT** - Contains replaceable nylon trimming line that advances when the trimmer head is tapped against the ground while the head is turning at normal operating speed.
8. **CUT-OFF KNIFE** - Automatically trims line to the correct length: 5" - after head is tapped on the ground. If trimmer is operated without a cut-off knife the line will become too long, the engine will overheat and engine damage may occur.
9. **PLASTIC DEBRIS SHIELD ASSEMBLY** - Included in plastic bag (co-pack). **MUST** be installed on unit before use, see Assembly Instructions. Shield assembly includes the Cut-Off Knife and Safety Decal. Mounts on the Gear Housing Assembly just above the cutting attachment. Helps protect the operator by deflecting debris produced during the trimming operation. This shield must be replaced with the steel shield for blade use.
10. **THROTTLE TRIGGER** - Spring loaded to return to idle when released. During acceleration, press trigger gradually for best operating technique.
11. **ARM REST** - Provides arm rest during operation and protects arm from the hot engine.
12. **SPARK PLUG** - Provides spark to ignite fuel mixture.
13. **SPARK ARRESTOR - CATALYTIC MUFFLER/MUFFLER** - The muffler or catalytic muffler controls exhaust noise and emission. The spark arrestor screen prevents hot, glowing particles of carbon from leaving the muffler. Keep exhaust area clear of flammable debris.
14. **FUEL TANK** - Contains fuel and fuel filter.
15. **RECOIL STARTER HANDLE** - Pull recoil handle slowly until starter engages, then quickly and firmly. When engine starts, return handle slowly. **DO NOT** let handle snap back or damage to unit will occur.
16. **FUEL TANK CAP** - Covers and seals fuel tank opening.
17. **PRIMER BULB** - Pumping primer bulb before starting engine draws fresh fuel from the fuel tank priming the carburetor for starting. Pump primer bulb until fuel is visible and flows freely in the clear fuel tank return line. Pump bulb an additional 4 or 5 times.
18. **AIR CLEANER** - Contains replaceable filter element.
19. **CHOKE** - The choke control lever is located on the top of the air filter case. Move lever to "COLD START" to close choke for cold starting. Move lever to "RUN" position to open choke.
20. **HIP PAD** - (SRM-2110) Used to protect hip/leg and clothing when using U-handle equipped unit.
21. **SHOULDER HARNESS** - Optional SRM-2100, Standard on SRM-2110. An adjustable strap that suspends the unit from the operator. Using the strap reduces operator fatigue.
22. **METAL BLADE SHIELD** - (SRM-2110) Required when unit is equipped with blades. Do not operate unit without shield.
23. **BLADE** - Circular blade for grass, weed or brush cutting applications. Harness, metal shield and U-handles are required for blade operation.
24. **U-HANDLE** - (SRM-2110) Required for metal blade operation.
25. **SAFETY VIDEO** (Not included with unit) - 99922202540 English version only) is available at a cost of \$5.00 from ECHO, INC. or any authorized ECHO dealer. The video overviews safety precautions and proper operating techniques and is supplemental to the Safety Manual. Read and understand the Safety Manual for complete information on safe operation.

## SPECIFICATIONS

| MODEL                                 | SRM-2100  | SRM-2110          |
|---------------------------------------|---|-------------------|
| Length                                | 1500 mm (59 in.)  |                   |
| Width                                 | 330 mm (13.0 in.)   | 600 mm (23.6 in.) |
| Height                                | 300 mm (11.8 in.)   | 360 mm (14.2 in.) |
| Weight (dry) w/cutter head            | 5.2 kg (11.4 lb.)   | 5.8 kg (12.7 lb.) |
| Engine Type                           | Air cooled, two-stroke, single cylinder gasoline engine   |                   |
| Bore                                  | 32.2 mm (1.268 in.)   |                   |
| Stroke                                | 26.0 mm (1.02 in.)  |                   |
| Displacement                          | 21.2 cc (1.29 cu. in.)  |                   |
| Exhaust                               | Spark Arrestor Muffler  |                   |
| Carburetor                            | Zama diaphragm model C1U w/primer   |                   |
| Ignition System                       | Flywheel magneto, capacitor discharge ignition type   |                   |
| Spark Plug                            | NGK BPM-7A Gap 0.65 mm (0.026 in.)  |                   |
| Fuel                                  | Mixed (Gasoline and Two-stroke Oil)   |                   |
| Fuel/Oil Ratio                        | 50:1 ECHO High Performance, two-stroke air cooled engine oil  |                   |
| Gasoline                              | 89 Octane unleaded. DO NOT use fuel containing methyl alcohol, more than 10% ethyl alcohol or 15% MTBE. |                   |
| Oil                                   | 50:1 ECHO High Performance, two-stroke air cooled engine oil  |                   |
| Fuel Tank Capacity                    | 0.4 lit. (14.0 US fl. oz.)  |                   |
| Recoil Starter System                 | Automatic Recoil Starter  |                   |
| Clutch                                | Centrifugal Type  |                   |
| Drive Shaft                           | 1/4" Flex Shaft   |                   |
| Rotating Direction                    | Counter-Clockwise viewed from top   |                   |
| Cutter Head                           | Nylon line head (2-line) with .095 Crossfire™ Line capacity 6m (20 ft.)                                 |                   |
| Handle*                               | Front - Loop and Right Rear Handle w/rubber grips   |                   |
| U-Handle                              | Standard on SRM-2110  |                   |
| Shoulder Harness                      | Optional  | Standard          |
| Idle Speed RPM                        | 2800 - 3200   |                   |
| Wide Open Throttle Speed (W.O.T.) RPM | 9500 - 11000  |                   |

\* Install and use U-Handle when operating any model with blade.

## ASSEMBLY

### WARNING DANGER

Use only ECHO approved attachments for these models. Serious injury may result from the use of non approved attachment combinations. Read and comply with all safety instructions listed in this manual and attachment manual.

ECHO, INC. will not be responsible for the failure of cutting devices, attachments or accessories which have not been tested and approved by ECHO for use with these units.

### PLASTIC SHIELD INSTALLATION

(for Nylon Line Operation)

*Tools Required:* Screwdriver.

*Parts Required:* Plastic Shield, Shield Plate, three (3) 5mm x 15mm screws.

#### NOTE

The plastic shield is for use with the Nylon Line Head only.  
Install Metal Shield when using plastic or metal blades.

1. Remove plastic threaded shaft sleeve and adapter plate (C) from PTO shaft (A).
2. Place the shield on the bottom of the bearing housing flange.
3. Place shield plate (B) on shield, align holes. Install three (3) screws from bottom through plate and shield into gear case.
4. Assemble adapter plate (C) onto PTO shaft.

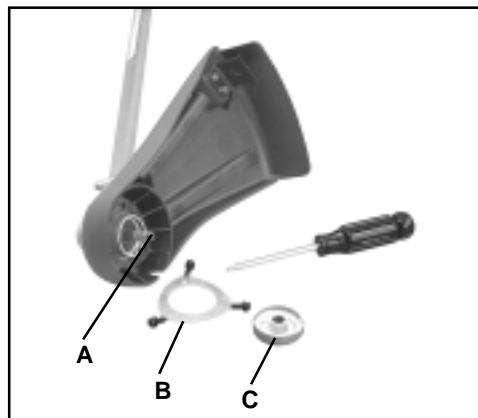

### NYLON LINE HEAD INSTALLATION

*Tools Required:* Head Locking Tool

*Parts Required:* Nylon Line Head.

1. Be sure adapter plate (C) remains on PTO shaft.
2. Align locking hole in upper plate with notch in edge of gear housing and insert head locking tool (D).
3. Thread line head onto shaft by turning it counter clockwise until head is tight against adapter plate (C).

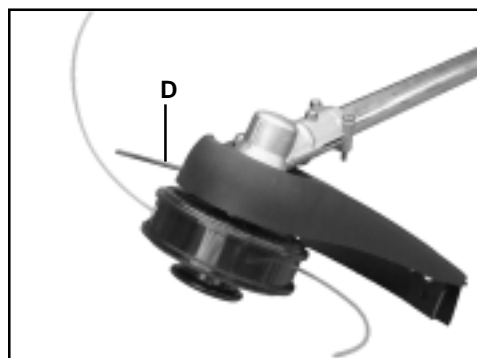

## BLADE INSTALLATION

All Models.

### IMPORTANT

If non-standard monofilament head, METAL/PLASTIC blade or cultivator etc. is used, THE CARBURETOR MUST BE RE-SET or serious engine damage may occur. See "Carburetor Adjustment" page 27 and "Specifications" page 11 of this manual.

### WARNING DANGER

You must install a U-Handle Kit and Blade Conversion kit before operating this unit using metal blades, otherwise serious injury may result.

### Install Metal Shield

**Tools Required:** 8mm x 10mm Open End Wrench, Screwdriver, Srench, Locking Tool.

**Parts Required:** Metal Shield, Bracket, 3- 5mm x 15mm screws w/ captivated flat and lockwasher (metal shield to gear housing), 2- 5mm x 8mm screws, 4- 5mm nuts, 4- 5mm lockwashers (bracket to shield and bracket to gear housing).

1. If necessary, remove nylon line head and plastic shield.
2. Loosely attach bracket (A) to shield (B) and attach to bottom of gear housing (C) with screws and nuts provided. Tighten all attaching hardware.

### Install Blade

**Tools Required:** Locking Tool, srench.

**Parts Required:** Upper Plate w/ 20mm pilot, Lower Plate, 10mm Nut w/ LH threads, 2mm x 25mm Split Pin (cotter pin).

3. Install upper plate (D) on splined PTO shaft. Blade installation requires use of Upper Plate (D) with 20mm pilot. Upper plate with 37mm pilot of the SRM-2100 should be retained for use with nylon line head.
4. Place Blade (E) over upper plate pilot, install the Lower Plate (F) and 10mm LH nut (G). Tri-Cut Blade (H) is installed with Glide Cup (J).
5. Insert Locking Tool (K) through hole in upper plate and notch in gear housing to prevent splined PTO shaft from turning. Tighten nut and secure with Split Pin (L).

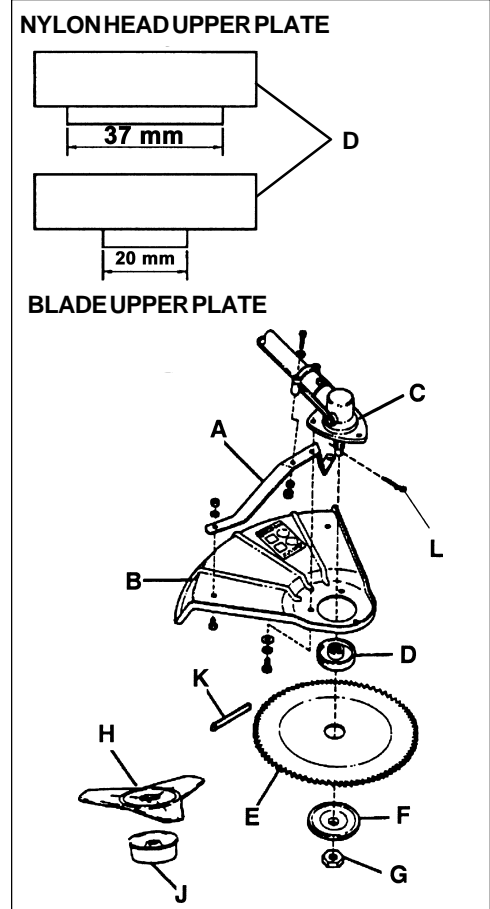

## Install Harness Clamp

### NOTE

Some models require installation of Harness Clamp. If your unit does not have a clamp, follow these directions.

*Tools Required:* Screwdriver, 8mm x 10mm Open End Wrench.

*Parts Required:* Clamp, 4mm x 18mm Hexagon Head, Bolt, Link.

6. Remove shield and gear housing as an assembly.
  - a. Loosen two (2) screws that clamp the gear housing to the drive shaft housing.
  - b. Remove locating screw found at the top of the gear housing. Pull shield and gear housing assembly from the drive shaft assembly.

### IMPORTANT

Prevent flexible drive cable from sliding from drive shaft housing. If cable does slide free, clean dirt from cable and lubricate with lithium based grease prior to re-assembly.

7. Remove front handle.
  - a. Remove four (4) screws and nuts and handle support from front handle.
  - b. Remove front handle.
8. Install clamp.
  - Slightly spread clamp and slide up shaft.
  - Install single link using spacer, DO NOT tighten at this time.
9. Install gearbox, shield and front handle.
10. Balance unit.
  - a. Put on harness and attach unit to harness.
  - b. Slide clamp up or down until unit balances with head approximately 2" - 3" from the ground.
  - c. Tighten clamp screw.



## THROTTLE LINKAGE AND IGNITION LEADS

*Tools Required:* 8mm x 10mm open end wrench (all models), 3mm Allen Wrench.

1. Close choke and remove air filter cover.
2. Loosen nut (A) and place threaded end of throttle linkage in bracket slot. Finger tighten nut (A).
3. Place inner cable in slot of carburetor swivel (B) and tighten nut (A).
4. Check throttle for freedom of movement and make sure it returns to idle position. If the throttle linkage does not allow the carburetor throttle plate (C) to return to idle against idle screw (D), loosen linkage nuts; turn throttle linkage nut (A) counter clock wise until throttle plate (C) just rests against idle screw (D). Hold linkage nut (A) from turning and tighten other linkage nut.
5. Connect ignition leads (C). SRM-2100 has one connector terminal pair and one ring terminal which attaches under fan terminal screw (C).
6. Install air filter and cover.

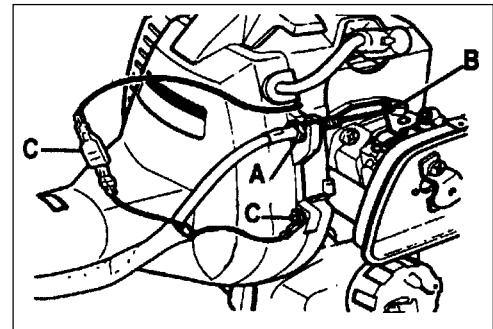
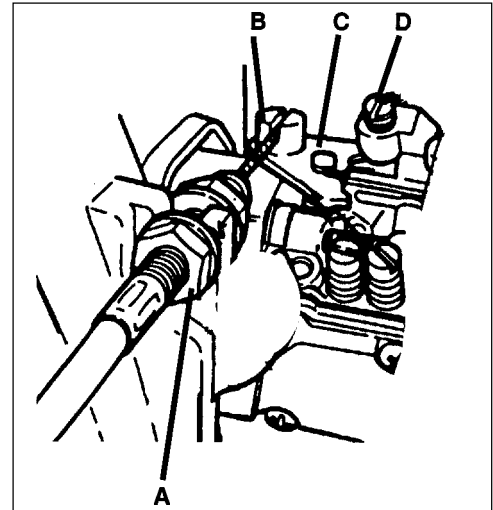

## FRONT HANDLE INSTALLATION

*Tools Required:* Screwdriver.

*Parts Required:* Front Handle, Handle Support, Four (4) 5mm x 35mm screws with captivated washers, four (4) 5mm nuts.

1. Position front handle for comfortable operation and secure screws.



## U-HANDLE INSTALLATION

*Tools Required:* 8mm x 10mm Open End Wrench, Slotted Screwdriver, (3mm Hex Wrench SRM-2100 only.)

*Parts Required:* U-Handle Kit. (SRM-2100) P/N 35130454130

### NOTE

On model SRM-2110 use Steps 1, 10, 11, and 13 - 17 only.

1. Close choke and remove air filter cover.
2. Disconnect ignition stop leads (C).
3. Remove inner throttle linkage from carburetor swivel (B).
4. Loosen nut (A) and remove throttle linkage from bracket.
5. Loosen two (2) bolts (D) and pull drive shaft assembly from clutch case.
6. Loosen two (2) rear handle screws (E) and pull rear handle (F) from the drive shaft assembly.
7. Loosen four (4) screws and remove front handle (G).

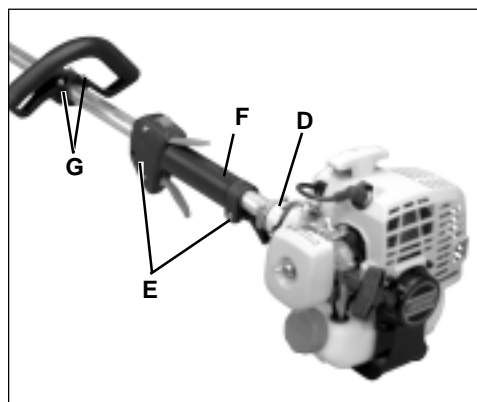
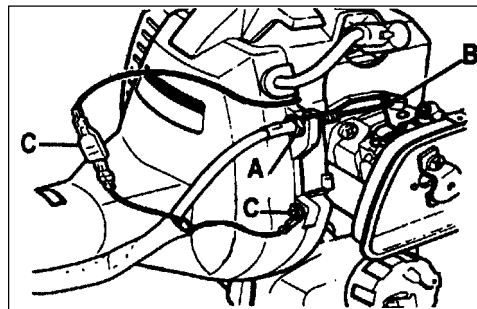

8. Position Lower U-Handle Bracket (H) 400mm (15-3/4 in.) from engine end of drive shaft. Secure with three (3) 5mm x 30mm bolts.
9. Install harness hook (included with Blade Conversion Kit) for blade use. Position 220 mm (8-5/8 in.) from engine end of drive shaft assembly. DO NOT tighten at this time.

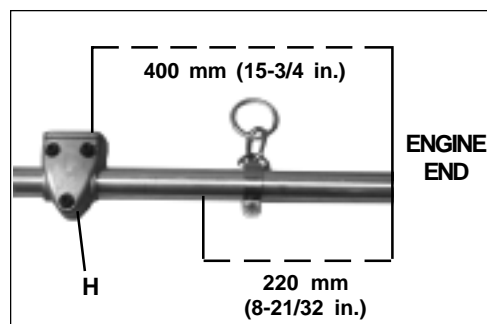

10. Install upper U-Handle and bracket on lower bracket and secure with one (1) 8mm x 55mm bolt (J) and large circular washer.

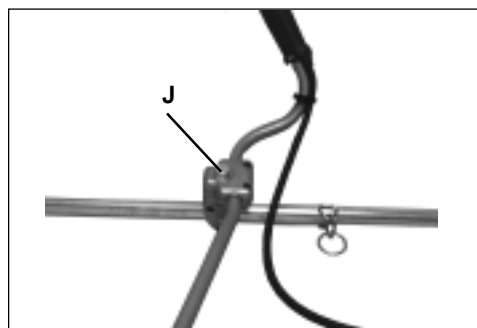



11. Secure throttle linkage and leads to drive shaft with cable clips supplied.
12. Install power head and align gear box, power head and U-handles. Tighten all screws.

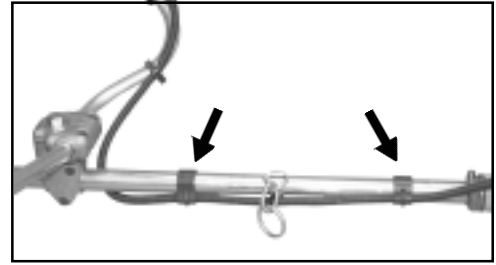

13. Place throttle linkage in slot in bracket with one nut (A) and washer on each side of bracket. Finger tighten both nuts (A).
14. Attach inner throttle cable to swivel (B). Check throttle for freedom of movement and that wide open throttle / low idle extremes are adjusted properly. If adjustment cannot be achieved by adjusting nuts (A), consult with your Echo Dealer for correct adjustment procedure.

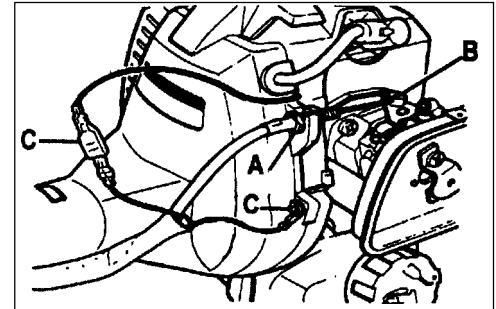

15. Attach ignition leads (C).

16. Install air filter and cover.

17. Balance unit.

- a. Put on harness and attach unit to harness.
- b. Slide clamp (K) up or down drive shaft housing until unit balances with cutting attachment approximately 2 - 3 in. from ground.
- c. Tighten harness clamp screw.

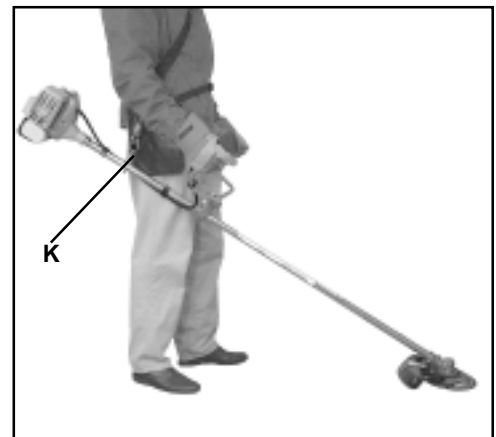

## PRE - OPERATION

### OPERATION WITH BLADES

#### *Preparing the Trimmer/Brush Cutter for Blade Use*

#### WARNING DANGER

Blade use **DEMANDS** specific Brush Cutter configuration. Operation without specified shield and harness can result in serious personal injury.

**Plastic and Nylon Blades Require** "Blade Conversion Kit," P/N 99922200415 (metal shield, barrier bar, and shoulder harness).



**Steel/Metal Blades Require** "Blade Conversion Kit" **PLUS** a "U-Handle Kit." P/N 35130454130 or Combination Blade Kit and "U-Handle Kit" P/N 99944200451.



#### *Choosing the Correct Blade*

#### WARNING DANGER

The type of Blade used **MUST** be matched to the type and size of material cut. An improper or dull blade can cause serious personal injury. Blades **MUST** be sharp. Dull blades increase the chance of kick out and injury to yourself and bystanders.

**Plastic/Nylon Blades** may be used where ever the nylon line head is used. **DO NOT** use this blade for heavy weeds or brush!

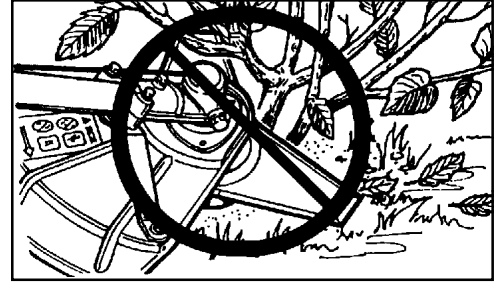

**8 Tooth Weed/Grass Blade P/N 69600120331** is designed for grass, garden debris and thick weeds. **DO NOT** use this blade for brush or heavy woody growth, 3/4" in. (19 mm) diameter or larger.

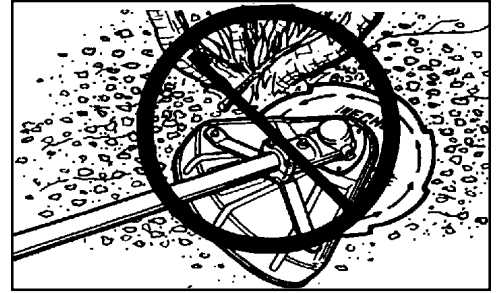

**Brush/Clearing Blade P/N 69500120331** is designed for cutting brush and woody growth up to 76 mm (3" in.) diameter.



**Use Shoulder/Waist Harness P/N 99944200200** Use of the Shoulder/Waist Harness is recommended for **ALL** Trimmer/Brush Cutter use, not just Blade operation. The Shoulder/Waist Harness when used in a trimming operation with nylon line head suspends the trimmer from the operator's shoulder and reduces operator fatigue.



During blade operation, the same fatigue reduction is achieved. Safety to the operator is also enhanced by preventing blade contact with the operators hands and feet by restricting trimmer movement.

**NOTE**

In case of Emergency, pull up on the Quick Release Collar to disconnect the trimmer from the harness.

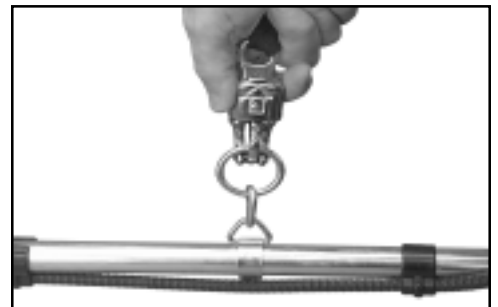

## FUEL

### Fuel Requirements

**Gasoline** - Use 89 Octane [ $\frac{R+M}{2}$ ] gasoline or gasohol known to be good quality. Gasohol may contain up to 10% Ethyl (grain) alcohol or 15% MTBE (methyl tertiary-butyl ether). Gasohol containing methyl (wood) alcohol is **NOT** approved.

**Two Stroke Oil** - A two-stroke engine oil meeting ISO-L-EGD Standard (ISO/CD 13738), must be used. Echo brand Premium 50:1 oil meets this standard. Engine problems due to inadequate lubrication caused by failure to use an ISO-L-EGD approved oil, such as Echo Premium 50:1 Two-stroke Oil, will void the two-stroke engine warranty. (Emission related parts only are covered for two years, regardless of two-stroke oil used, per the statement listed in the EPA Phase II Emission Defect Warranty Explanation.)

#### **IMPORTANT**

Echo Premium 2-Stroke Oil may be mixed at 50:1 ratio for application in all Echo engines sold in the past regardless of ratio specified in those manuals.

### Mixing Instructions

1. Fill an approved fuel container with half of the required amount of gasoline.
2. Add 2-stroke oil to gasoline.
3. Close container and shake to mix oil with gasoline.
4. Add remaining gasoline and remix.
5. Install fuel container cap and wipe any spilled fuel from container and surrounding area.

### Handling Fuel

#### **WARNING** **DANGER**

Fuel is **VERY** flammable. Use extreme care when mixing, storing or handling, or serious personal injury may result.

- Use an approved fuel container.
- **DO NOT** smoke near fuel.
- **DO NOT** allow flames or sparks near fuel.
- Fuel tanks/cans may be under pressure. Always loosen fuel caps slowly allowing pressure to equalize.
- **NEVER** refuel a unit when the engine is **HOT!**
- **NEVER** refuel a unit with the engine running.
- **DO NOT** fill fuel tanks indoors. **ALWAYS** fill fuel tanks outdoors over bare ground.
- Securely tighten fuel cap after refueling.
- Inspect for fuel leakage. If fuel leakage is found, do not start or operate unit until leakage is repaired.

#### **IMPORTANT**

Spilled fuel is a leading cause of hydrocarbon emissions. Some states may require the use of automatic fuel shut-off containers to reduce fuel spillage. Contact your ECHO dealer for ordering information.

### *After refueling;*

- Wipe any spilled fuel from the unit.
- Move at least 3 m (10 ft.) from refueling location before starting the engine.

### *After use;*

- **DO NOT** store a unit with fuel in its tank. Leaks can occur. Return unused fuel to an approved fuel storage container.

### *Storage -*

Fuel storage laws vary by locality. Contact your local government for the laws affecting your area. As a precaution, store fuel in an approved, air tight container. Store in a well ventilated, unoccupied building, away from sparks and flames. Do not store fuel longer than 30 days.

#### **IMPORTANT**

Stored fuel ages. Do not mix more fuel than you expect to use in thirty (30) days, ninety (90) days when a fuel stabilizer is added.

#### **IMPORTANT**

Stored two-stroke fuel may separate. **ALWAYS** shake fuel container thoroughly before each use.

## OPERATION

### STARTING COLD ENGINE

#### WARNING DANGER

The cutting attachment should not move at idle. If cutting attachment moves, readjust carburetor according to "Carburetor Adjustment" instructions in this manual or see your ECHO Dealer, otherwise serious personal injury may result.

1. Stop Switch - Start/Run.  
Move stop switch button (A) forward away from the STOP position.
2. Choke - Cold Start.  
Move choke (B) to "Cold Start" Position.
3. Primer Bulb -Purge.  
Pump primer bulb (C) until fuel is visible and flows freely in the clear fuel tank return line. Pump bulb an additional 4 or 5 times.

#### WARNING DANGER

Inspect starting area for hazards such as rocks, glass, debris etc. which could be contacted by the cutting attachment when starting. Keep helpers and bystanders at least 15 m (50 ft.) from starting area, otherwise serious personal injury may result.

4. Lay the unit on a flat clear area. Firmly grasp right hand grip and throttle trigger lockout with left hand and fully depress throttle trigger to wide open position. Rapidly pull recoil starter handle/rope (D) until engine fires (or maximum five [5] pulls).
5. After engine fires (or five [5] pulls), move choke lever back to "Run" position. Hold throttle trigger and throttle trigger lockout fully depressed and pull recoil starter handle/rope until engine starts and runs. Release throttle trigger and allow unit to warm up at idle for several minutes.

#### NOTE

If engine does not start with choke in "Run" position after 5 pulls, repeat instructions.

6. After engine warm up, gradually depress throttle trigger to increase engine RPM to operating speed.

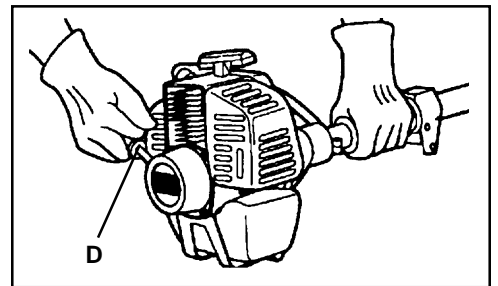
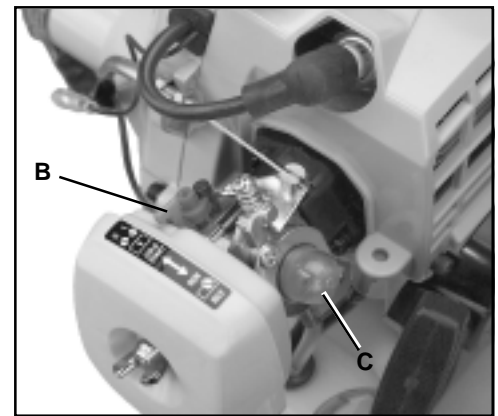
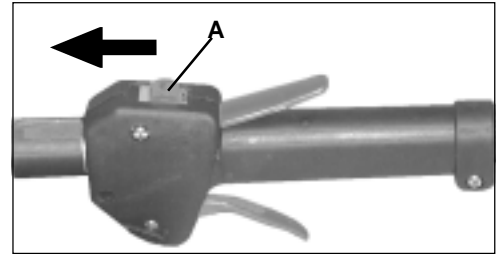

## STARTING WARM ENGINE

The starting procedure is the same as Cold Start except DO NOT close the choke.

### WARNING DANGER

The cutting attachment should not move at idle. If cutting attachment moves, readjust carburetor according to "Carburetor Adjustment" instructions in this manual or see your ECHO Dealer, otherwise serious personal injury may result.

1. Stop Switch - Start/Run. Move Stop Switch button (A) forward away from the STOP position.

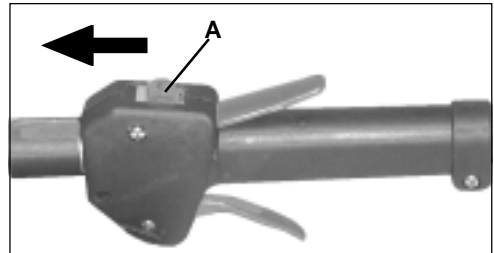

2. Start - Pull Rope. Lay the pruner on a flat clear area and pull the recoil starter handle (D) until the engine fires.

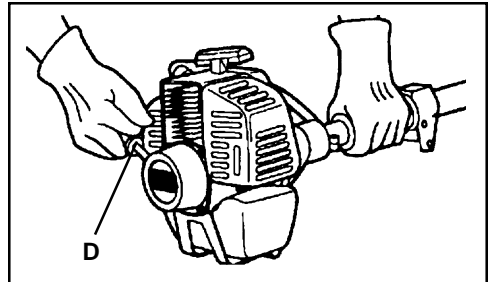

#### NOTE

If engine does not start after 5 pulls, use Cold Start Procedure.

## STOPPING ENGINE

1. Release Throttle. Allow engine to return to idle before shutting engine off.
2. Stop Switch - Stop. Move stop switch button (A) backward to STOP position.

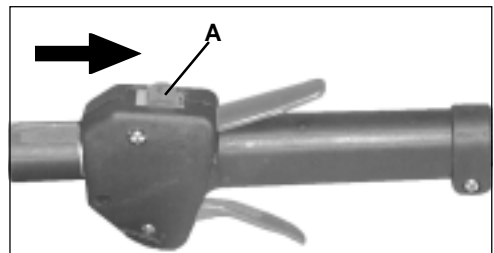

### WARNING DANGER

If engine does not stop when stop switch is moved to STOP position, close choke - COLD START position - to stall engine. Have your ECHO dealer repair stop switch before using trimmer again.

#### NOTE

Refer to the attachment Operator's Manual and Safety Manual (if included) for proper and safe operating techniques.

## MAINTENANCE

Your ECHO unit is designed to provide many hours of trouble-free service. Regular scheduled maintenance will help your unit achieve that goal. If you are unsure or are not equipped with the necessary tools, you may want to take your unit to an ECHO Service Dealer for maintenance. To help you decide whether you want to DO-IT-YOURSELF or have the ECHO Dealer do it, each maintenance task has been graded. If a task is not listed, see your ECHO Dealer for repairs.

### SKILL LEVELS

- Level 1** = Easy to do. Most required tools come with unit.
- Level 2** = Moderate difficulty. Some specialized tools may be required.
- Level 3** = Experience required. Specialized tools are required. ECHO recommends that the unit be returned to your ECHO dealer for service.

ECHO offers **REPOWER™** Maintenance Kits and Parts to make your maintenance job easier. Below each task heading are listed the various part numbers required for that task. See your ECHO dealer for these parts.

### MAINTENANCE INTERVALS

| COMPONENT/<br>SYSTEM                                  | MAINTENANCE<br>PROCEDURE | REQ'D<br>SKILL<br>LEVEL | DAILY OR<br>BEFORE<br>USE | EVERY<br>REFUEL | 3<br>MONTHS<br>OR 90<br>HOURS | 6<br>MONTHS<br>OR 270<br>HOURS | YEARLY<br>600<br>HOURS |
|---|--------------------------|-------------------------|---------------------------|-----------------|-------------------------------|--------------------------------|------------------------|
| <b>Recommended Echo Dealer Maintenance Procedures</b> |                          |                         |                           |                 |                               |                                |                        |
| Cylinder Exhaust Port                                 | Inspect/Clean/Decarbon   | 3                       |                           |                 | I / C                         |                                |                        |
| <b>Do-It-Yourself Maintenance Procedures</b>          |                          |                         |                           |                 |                               |                                |                        |
| Air Filter  | Inspect/Clean/Replace    | 1                       | I / C                     |                 | R*                            |                                |                        |
| Choke   | Inspect/Clean            | 2                       | I / C                     |                 |                               |                                |                        |
| Fuel Filter   | Inspect/Replace          | 1                       |                           |                 | I                             |                                | I / R *                |
| Fuel System, leaks                                    | Inspect/Replace          | 1                       | I *                       | I               | I                             |                                |                        |
| Cooling System  | Inspect/Clean            | 2                       | I / C                     |                 |                               |                                |                        |
| Muffler Spark Arrestor                                | Inspect/Replace          | 2                       |                           |                 | I / R *                       |                                |                        |
| Drive Shaft (Flex Cable Models)                       | Grease                   | 2                       |                           |                 | I (1)                         |                                |                        |
| Gear Housing  | Grease                   | 2                       |                           |                 | I (2)                         |                                |                        |
| Recoil Starter Rope                                   | Inspect/Clean            | 1                       | I / C *                   |                 |                               |                                |                        |
| Spark Plug  | Inspect/Clean            | 2                       |                           |                 | I / C                         | R *                            |                        |
| Screws/Nuts/Bolts                                     | Inspect/Tighten/Replace  | 1                       | I / R *                   |                 |                               |                                |                        |

**MAINTENANCE PROCEDURE LETTER CODES: I = INSPECT, R = REPLACE, C = CLEAN**

**IMPORTANT NOTE** - Time intervals shown are maximum. Actual use and your experience will determine the frequency of required maintenance.

**MAINTENANCE PROCEDURE NOTES:**

(1) Apply ECHO® LUBE™ every 25 hours of use.

(2) Apply ECHO® LUBE™ every 50 hours of use.

\* All recommendations to replace are based on the finding of damage or wear during inspection..

## AIR FILTER

### Level 1.

*Tools required:* Cleaning Brush

*Parts required:* 90008 REPOWER AIR & FUEL FILTER KIT.

1. Close choke (Cold Start Position). This prevents dirt from entering the carburetor throat when the air filter is removed. Brush accumulated dirt from the air cleaner area.
2. Remove the air cleaner cover. Clean and inspect the element for damage. If element is fuel soaked and very dirty, replace.
3. If element can be cleaned and reused, be certain it:
  - still fits the cavity in the air cleaner cover.
  - is installed with the original side out.

#### NOTE

Carburetor adjustment may be needed after air filter cleaning/replacement.

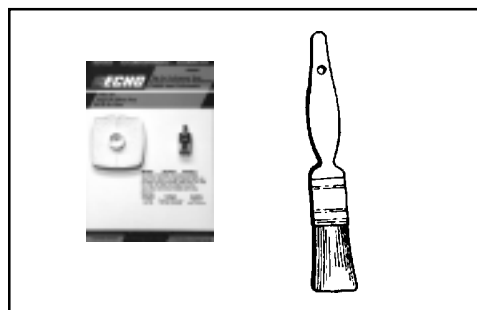

## FUEL FILTER

### Level 1.

*Tools required:* 200-250 mm (8 -10 in.) length of wire with one end bent into a hook, Clean rag, funnel, and an approved fuel container

*Parts required:* 90008 REPOWER AIR & FUEL FILTER KIT.

#### WARNING DANGER

Fuel is **VERY** flammable. Use extreme care when mixing, storing or handling, or serious personal injury may result.

1. Use a clean rag to remove loose dirt from around fuel cap and empty fuel tank.
2. Use the "fuel line hook" to pull the fuel line and filter from the tank.
3. Remove the filter from the line and install the new filter.

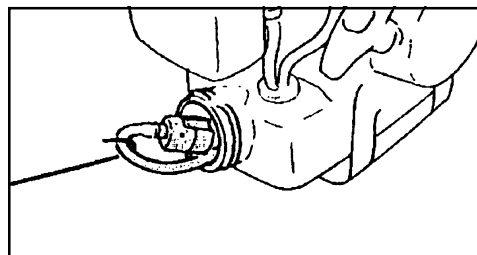



## SPARK PLUG

### Level 2.

*Tools required:* Srench (combination socket wrench and screw driver supplied with unit), Feeler gauge (preferably a wire gauge), Soft metal brush

*Parts Required:* Spark Plug NGK BPM-7A

1. Remove spark plug and check for fouling, worn and rounded center electrode.
2. Clean the plug or replace with a new one. DO NOT sand blast to clean. Remaining sand will damage engine.
3. Adjust spark plug gap by bending outer electrode.
4. Tighten spark plug to 145 - 155 kg/cm (125 - 135 in. lb.).

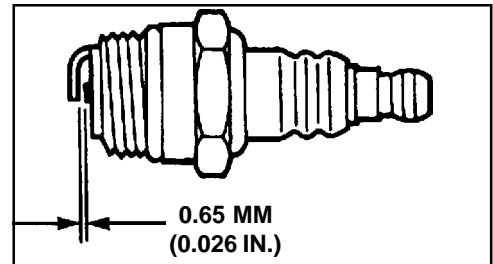
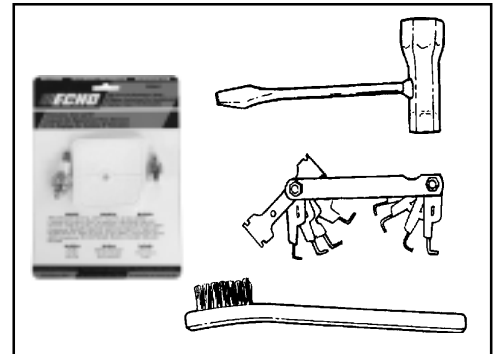

## COOLING SYSTEMS CLEANING

### Level 2.

*Tools required:* Cross-head screwdriver, 3 mm hex wrench, pointed wood stick

*Parts Required:* None if you are careful.

### IMPORTANT

To maintain proper engine operating temperatures, cooling air must pass freely through the cylinder fin area. This flow of air carries combustion heat away from the engine.

Overheating and engine seizure can occur when:

- Air intakes are blocked, preventing cooling air from reaching the cylinder.
- Dust and grass build up on the outside of the cylinder. This build up insulates the engine and prevents the heat from leaving.

Removal of cooling passage blockages or cleaning of cooling fins is considered "Normal Maintenance". Any failure attributed to lack of maintenance is not warranted.

1. Remove spark plug lead and throttle linkage end from the carburetor swivel.

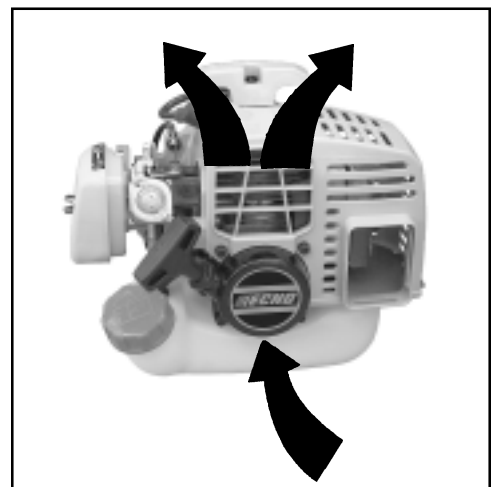
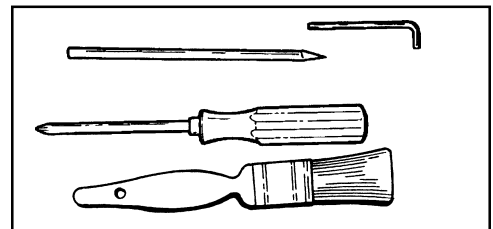

- Remove the four screws that retain the engine cover (A). Two at the top of the starter, two on either side of the front. Lift the cover from the engine and lay to the front of the trimmer.

**NOTE**

The throttle linkage remains assembled to the cover and the spark plug lead and grommet remain installed.

- Use the wooden stick or brush to remove dirt from cylinder fins.
- Remove grass and leaves from the grid between the recoil starter and fuel tank.
- Assemble components in reverse order.

**NOTE**

When installing the cover, be certain the tab of the metal deflector shield is in the slot of the engine cover.

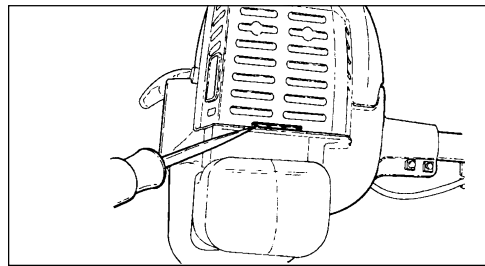
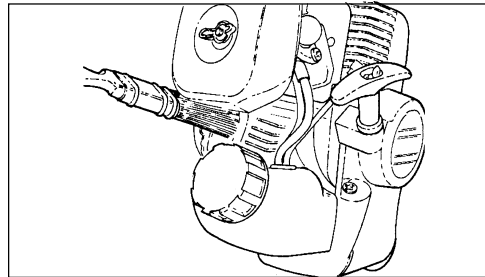
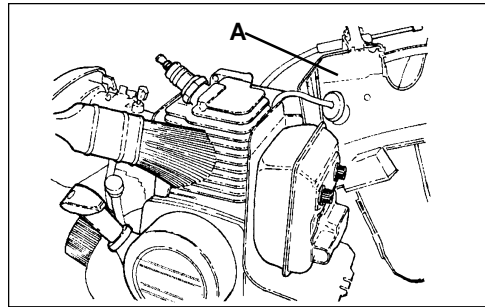

## EXHAUST SYSTEM

### Spark Arrestor Screen

**Level 2.**

*Tools required:* Cross-head screwdriver, soft metal brush, wooden carbon scraper.

*Parts Required:* Screen P/N 14586240630, Gasket Lid P/N 14586642031

- Remove engine cover (A). See "Cleaning Cooling System" pages 25 & 26 for step by step instructions.
- Place piston at Top Dead Center (TDC) to prevent carbon/dirt from entering cylinder.
- Remove spark arrestor screen cover (B), screen holder (C), gasket (D) and screen (E) from muffler body.
- Clean carbon deposits from screen and muffler components.
- Replace screen if it is cracked, plugged or has holes burned through.
- Assemble components in reverse order.

**NOTE**

When installing the engine cover, be certain the tab of the metal deflector shield is in the slot of the engine cover.

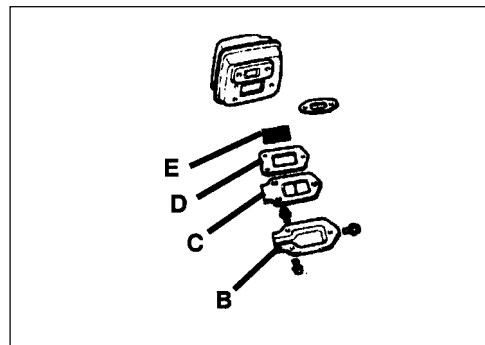
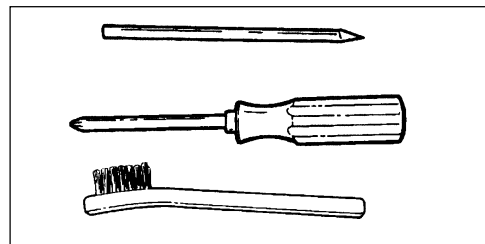

### CARBURETOR ADJUSTMENT

#### *Emission Models*

#### **Level 2.**

*Tools required:* Slotted Screwdriver w/2 mm blade width, Tachometer (ECHOP/N99051130017)

*Parts required:* None.

#### **NOTE**

Every unit is run at the factory and the carburetor is set in compliance with EPA Phase 1 and California Emission Regulations. In addition, the carburetor is equipped with HI and LO needle adjustment limiters that prevent settings outside acceptable limits.

1. Before adjusting the carburetor, clean or replace the air filter and spark arrester screen.
2. Trimmer line must be extended to the cut-off knife.
3. Start engine and run for several minutes to reach operating temperature.
4. Stop engine. Turn HI speed needle (A) CCW (counter clockwise) to stop. Turn LO speed needle (B) midway between full CCW and CW (clockwise) stops.
5. Idle Speed Adjustment.  
Start engine and turn "idle" speed adjustment screw (C) CW until the cutting attachment begins to turn, then turn the screw CCW until cutting attachment stops turning. Turn screw CCW an additional 1/4 turn.
5. Accelerate to full throttle for 2-3 seconds to clear excess fuel from engine then return to idle. Accelerate to full throttle to check for smooth transition from idle to full throttle. If engine hesitates, turn LO needle (B) CCW an additional 1/8 turn and repeat acceleration. Continue adjusting until smooth acceleration results.
6. Check HI speed RPM at W.O.T. (Wide Open Throttle). HI speed RPM should be set to specifications found on page 11 "Specifications" of this manual.
7. Check idle speed and reset if necessary. If a tachometer is available, idle speed should be set to the specification found on page 11 "Specifications" of this manual.

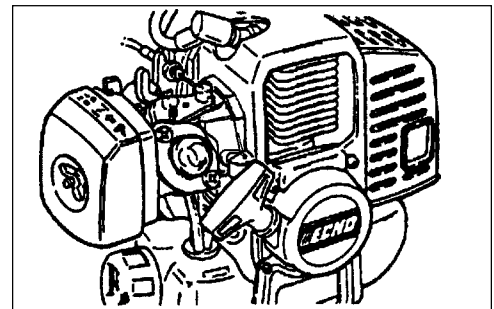
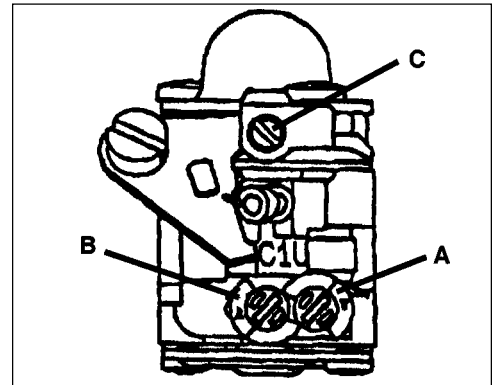
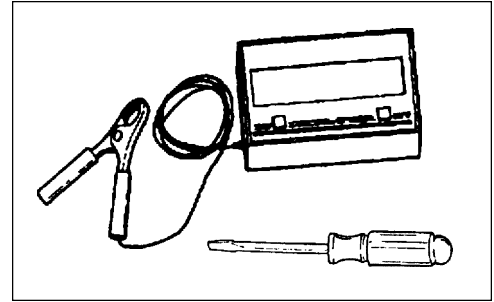

### **WARNING** **DANGER**

When carburetor adjustment is completed, the cutting attachment should not rotate at idle, otherwise serious personal injury may result.

## LUBRICATION

### Level 1.

*Tools required:* 8 mm Open End Wrench, Cross Head Screwdriver, Clean rag

*Parts Required:* ECHO® LUBE™ 8 oz. (P/N 91014) or Lithium Base Grease.

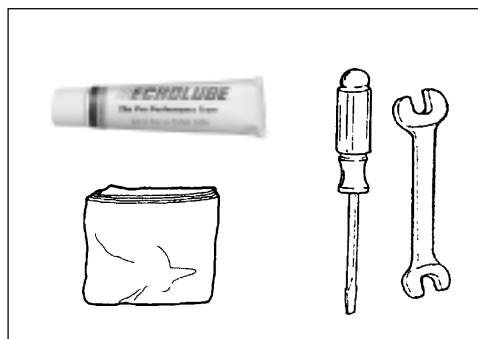

### Gear Housing

1. Clean all loose debris from gear box.
2. Remove plug (A) and check level of grease.
3. Add grease if necessary, DO NOT over fill.

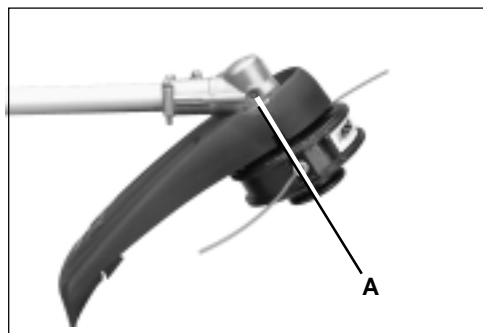

### Drive Shaft

1. Loosen two (2) screws (B) and remove center locating screw (C). Pull gear box and shield from drive shaft housing.
2. Pull flexible cable from the drive shaft housing, wipe clean and recoat with a thin coating of [15 ml (1/2 oz.)] of high temperature automotive grease.
3. Slide the flexible cable back in the drive housing. DO NOT get dirt on the flex cable.
4. Install the gear housing and shield assembly.

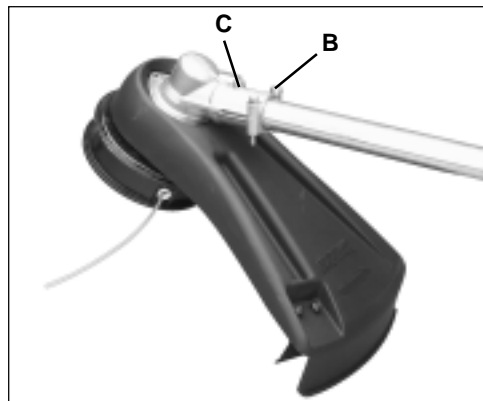

## NYLON LINE REPLACEMENT

### Level 1.

*Tools required:* Head locking tool (if head is to be removed)

*Parts Required:* ECHO 0.095" Nylon Trimmer Line 6m (20 ft.) long.

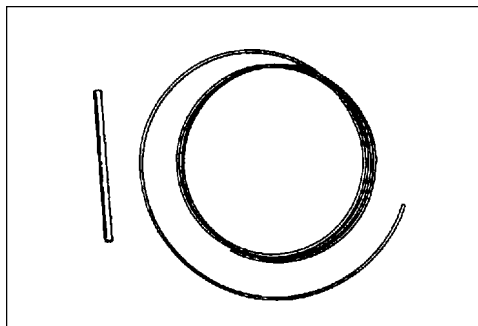

1. Shut engine off. Lay unit on the ground with head assembly up.
2. Hold drum (A) and turn spool (B) CW (clockwise) until it stops. Pull spool from drum. DO NOT push in on spool when turning.

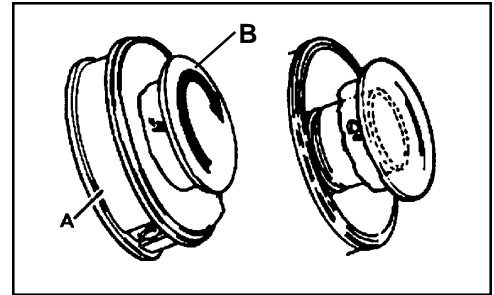

3. Use one piece of new nylon line (C) 6m (20 ft.) long and thread through the molded loop (D) on the spool. Pull line tight and adjust so one end is 15 cm (6 in.) longer than the other.
4. Hold the spool, opening toward you. Place index finger between the two strands and wind line, tightly and evenly, in direction of arrow marked "CC".
5. Stop when approximately 15-20 cm (6-8 in.) line (C) remains and place ends of line in notches (E) in spool (B).

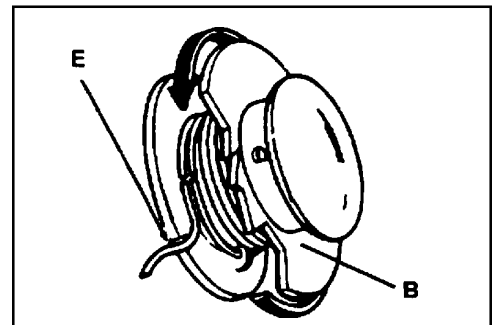
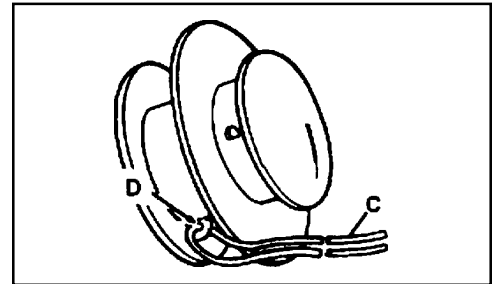

6. Feed ends of line through housing eyelets (F) and place spool (B) over drive (G). Align pegs (H) on drive with notches in spool and push spool into drum.

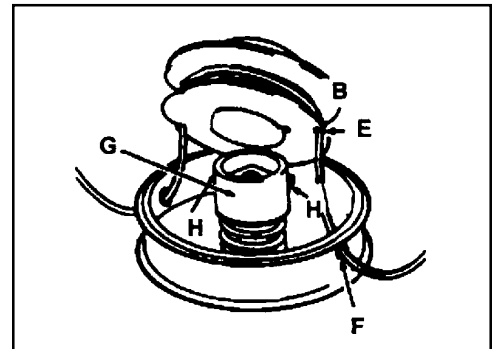

7. Pull on both lines until they come free from notches (E) in spool.

8. Hold drum (A) firmly and turn spool (B) CCW (counterclockwise) until it stops. DO NOT push in on spool when turning.
9. Pull both lines out and trim to cut-off knife length.

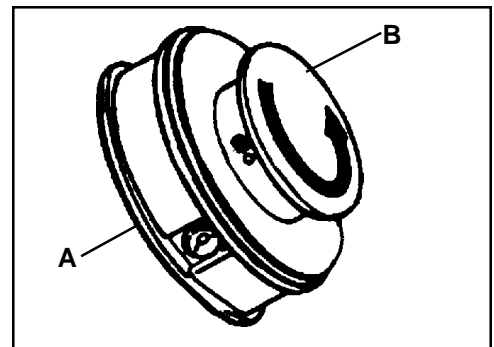

## SHARPENING METAL BLADES

Three styles of metal blades are approved for use on the ECHO Brush Cutter. The 8-tooth blade can be sharpened during normal maintenance. The clearing blade and 80 tooth blade require professional service.

Before sharpening, CLOSELY inspect blade for cracks (look at the bottom of each tooth and the center mounting hole closely), missing teeth and bending. If ANY of these problems are discovered, replace the blade.

When sharpening a blade, always remove the same amount of materials from each tooth to maintain balance. A blade that is not balanced will cause unsafe handling due to vibration and can result in blade failure.

### 8-tooth Blade

*Tools required:* Flat file (preferred), Electric grinder if special care is used, Round (rat tail) file for gullet (radius).

1. File each tooth at a 30 degree angle a specific number of times, eg. 4 strokes per tooth. Work your way around the blade until all teeth are sharp.
2. DO NOT file the 'gullet' (radius) of the tooth with the flat file. The radius must remain. A sharp corner will lead to a crack and blade failure.

#### **IMPORTANT**

If an electric grinder is used, use care not to overheat teeth, do not allow tips/tooth to glow red or turn blue. DO NOT place blade in cooling water. This will change the temper of the blade and could result in blade failure.

3. After sharpening teeth, check each tooth radius for evidence of a square (sharp) corner. Use the round (rat tail) file to renew the radius.

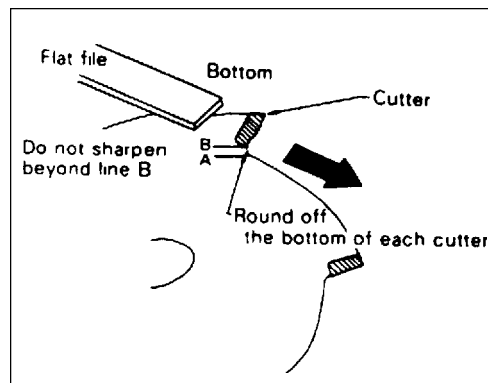
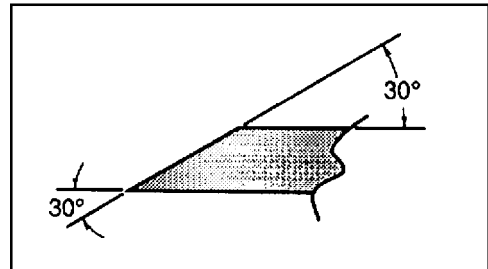
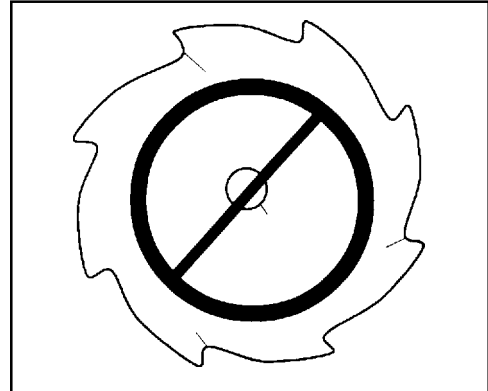

## TROUBLESHOOTING

**ENGINE PROBLEM TROUBLESHOOTING CHART**

| Problem   | Check                     | Status                        | Cause  | Remedy  |
|---|---------------------------|-------------------------------|--|---|
| Engine cranks - starts hard/ doesn't start            | Fuel at carburetor        | No fuel at carburetor         | Fuel strainer clogged<br>Fuel line clogged<br>Carburetor                         | Clean or replace<br>Clean or replace<br>See your Echo dealer                        |
|   | Fuel at cylinder          | No fuel at cylinder           | Carburetor   | See your Echo dealer  |
|   |                           | Muffler wet with fuel         | Fuel Mixture too rich  | Open choke<br>Clean/replace air filter<br>Adjust carburetor<br>See your Echo dealer |
|   | Spark at end of plug wire | No spark                      | Stop switch off<br>Electrical problem<br>Interlock switch                        | Turn switch to ON<br>See your Echo dealer<br>See your Echo dealer                   |
|   | Spark at plug             | No spark                      | Spark gap incorrect<br>Covered with carbon<br>Fouled with fuel<br>Plug defective | Adjust to .65mm (0.026 in.)<br>Clean or replace<br>Clean or replace<br>Replace plug |
| Engine runs, but dies or does not accelerate properly | Air filter                | Air filter dirty              | Normal wear  | Clean or replace  |
|   | Fuel filter               | Fuel filter dirty             | Contaminants/residues in fuel  | Replace   |
|   | Fuel vent                 | Fuel vent plugged             | Contaminants/residues in fuel  | Clean or replace  |
|   | Spark Plug                | Plug dirty/worn               | Normal wear  | Clean and adjust or replace   |
|   | Carburetor                | Improper adjustment           | Vibration  | Adjust  |
|   | Cooling System            | Cooling system dirty/plugged  | Extended operation in dirty/dusty locations                                      | Clean   |
|   | Spark Arrestor Screen     | Spark arrestor screen plugged | Normal wear  | Replace   |
| Engine does not crank                                 | N/A                       | N/A                           | Internal engine problem  | See your Echo dealer  |

**WARNING**  **DANGER**

Fuel vapors are **extremely** flammable and may cause fire and/or explosion. **Never** test for ignition spark near an open spark plug opening, otherwise serious personal injury may result.

## STORAGE

### *Long Term Storage (over 30 days)*

#### **WARNING** **DANGER**

During operation the muffler or catalytic muffler and surrounding cover become hot. Always keep exhaust area clear of flammable debris during transportation or when storing, otherwise serious property damage or personal injury may result

Do not store your unit for a prolonged period of time (30 days or longer) without performing protective storage maintenance which includes the following:

1. Store unit in a dry, dust free place, out of the reach of children.

#### **WARNING** **DANGER**

Do not store in enclosure where fuel fumes may accumulate or reach an open flame or spark.

2. Place the stop switch in the "OFF" position.
3. Remove accumulation of grease, oil, dirt, and debris from exterior of unit.
4. Perform all periodic lubrication and services that are required.
5. Tighten all the screws and nuts.
6. **Drain** the fuel tank **completely** and pull the recoil starter handle several times to remove fuel from the carburetor.
7. Remove the spark plug and pour 7 cc (1/4 oz.) (1/2 tablespoon) of fresh, clean, two-stroke engine oil into the cylinder through the spark plug hole.
  - A. Place a clean cloth over the spark plug hole.
  - B. Pull the recoil starter handle 2-3 times to distribute the oil inside the engine.
  - C. Observe the piston location through the spark plug hole. Pull the recoil starter handle slowly until the piston reaches the top of its travel and leave it there.
8. Install the spark plug (do not connect ignition cable).



**NOTES**

**NOTES**

**NOTES**

## SERVICING INFORMATION

### PARTS

Genuine ECHO Parts and ECHO Re Power Parts and Assemblies for your ECHO products are available only from an Authorized ECHO Dealer. When you do need to buy parts **always** have the Model Number, Type number and Serial Number of the unit with you. You can find all three numbers on the engine housing. For future reference, write them in the space provided below.

Model No. \_\_\_\_\_ Type No. \_\_\_\_\_ SN. \_\_\_\_\_

### SERVICE

Service of this product during the warranty period must be performed by an Authorized ECHO Service Dealer. For the name and address of the Authorized ECHO Service Dealer nearest you, ask your retailer or call: 1-800-432-ECHO (3246). When presenting your unit for Warranty service/repairs, proof of purchase is required.

### ECHO CONSUMER PRODUCT SUPPORT

If you require assistance or have questions concerning the application, operation or maintenance of this product, you may call the ECHO Consumer Product Support Department at 1-800-673-1558 from 8:30 am to 4:30 pm (Central Standard Time) Monday through Friday. Before calling, please know the model and serial number of your unit to help your Consumer Product Support Representative.

### WARRANTY REGISTRATION

You may register your Echo equipment using the warranty registration card or register on-line at [www.echo-usa.com](http://www.echo-usa.com). Registering provides a direct link between you and ECHO if we find it necessary to contact you.

### ADDITIONAL OR REPLACEMENT MANUALS

**Safety Manuals** in English/Spanish or English/French are available, free of charge, from your ECHO dealer or at [www.echo-usa.com](http://www.echo-usa.com).

**Operator's and Parts Manuals** are available by:

- Downloading free from [www.echo-usa.com](http://www.echo-usa.com)
- Purchasing from your Echo Dealer.
- Sending a check or money order for \$2.00 per Parts Catalog or \$1.50 per Operator's Manual made payable to ECHO, INCORPORATED. State on a sheet of paper the model number and serial number of the ECHO unit you have, part number of the manual (if known), your name and address, and mail to address below.

**Safety Videos** are available from your Echo dealer. A \$5.00 shipping charge is required for each video.

### Available Parts Catalog Parts Lists

SRM-2100/2110

TYPE 1ES/N001001 & UP

PARTNUMBER99922203493

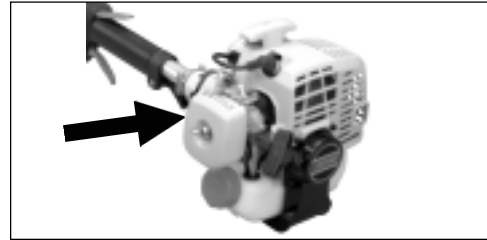

**DEALER?**

**CALL**

**1-800-432-ECHO**

**OR**

**[www.echo-usa.com](http://www.echo-usa.com)**

**CONSUMER PRODUCT  
SUPPORT**

**1-800-673-1558**

**8:30 - 4:30 MON - FRI C.S.T.**

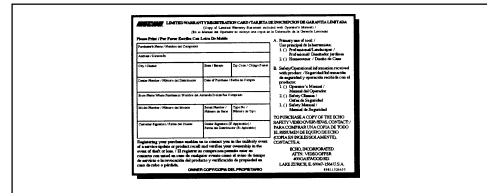

# **ECHO**®

**ECHO, INCORPORATED**

**400 OAKWOOD ROAD**

**LAKE ZURICH, IL 60047**

**[www.echo-usa.com](http://www.echo-usa.com)**



**SUPPLEMENT TO OPERATOR'S MANUAL  
PART NUMBER X7532278902 (89861554132)  
FOR MODEL: SRM-2100, SN 991201 & UP,  
SRM-2110, S/N 510001 & UP**

*Please use this Operator Manual Supplement when assembling and maintaining your SRM-2100 & SRM-2110*

**DESCRIPTION Page 7  
EMISSION CONTROL**

**IMPORTANT ENGINE INFORMATION**  
ENGINE FAMILY : 2EHXS.0214RA DISPLACEMENT : 21.2cc  
EMISSION COMPLIANCE PERIOD : 300 HRS.  
THIS ENGINE MEETS U.S. EPA PHASE 2 EMISSION  
REGULATIONS FOR SMALL NONROAD ENGINES. REFER  
TO OWNER'S MANUAL FOR MAINTENANCE SPECIFICA-  
TIONS AND ADJUSTMENTS.



**PRODUCT EMISSION DURABILITY**

The 300 hour emission durability compliance period is the time span selected by the manufacturer certifying the engine emissions output meets applicable U.S. EPA emissions regulations, provided that approved maintenance procedures are followed as listed in the Maintenance Section of this manual.

**PRE-OPERATION Page 20**

**FUEL**

**Two Stroke Oil** - A two-stroke engine oil meeting ISO-L-EGD (ISO/CD 13738) and J.A.S.O. FC Standards, must be used. Echo brand Premium 50:1 oil meets these standards. Engine problems due to inadequate lubrication caused by failure to use an ISO-L-EGD and J.A.S.O. FC certified oil, such as Echo Premium 50:1 Two-stroke Oil, will void the two-stroke engine warranty. (Emission related parts only are covered for two years, regardless of two-stroke oil used, per the statement listed in the EPA Phase II Defect Warranty Explanation.)

**MAINTENANCE**

**CARBURETOR ADJUSTMENT Page 27**

*Emission Models*

**NOTE**

Every unit is run at the factory and the carburetor is set in compliance with EPA Phase II Emission Regulations. In addition, the carburetor is equipped with HI and LO needle adjustment limiters that prevent settings outside acceptable limits.

**SUPLEMENTO DEL MANUAL DEL OPERADOR  
NÚMERO DE PIEZA X7532278902 (89861554132)**

**PARA LOS MODELO: SRM-2100 S/N 991201 y Superior, SRM-2110 S/N 510001 y Superior**

*Utilice por favor este suplemento manual del operador al ensamblar y manteniendo su SRM-2100 - SRM-2110*

**DESCRIPCIÓN Page 7**

**CONTROL DE EMISIONES**

**INFORMACIÓN IMPORTANTE SOBRE EL MOTOR**  
FAMILIA DE MOTORES: 2EHXS.0214RA CILINDRADA: 21.2 cc  
PERIODO DE LA CONFORMIDAD PARA LA EMISIONES : 300 HORAS.  
ESTE MOTOR RESUELVE LOS E.E.U.U. REGULACIONES DE LA EMISIÓN DE EPA PH2 PARA EL MOTOR PEQUEÑO DEL NONROAD. CONSULTE EN EL MANUAL DEL PROPIETARIO LAS ESPECIFICACIONES Y AJUSTES DE MANTENIMIENTO.



**DURABILIDAD DE LAS EMISIONES DEL PRODUCTO**

El período de durabilidad de conformidad para la emisiones de 300 horas es el tiempo seleccionado por el fabricante certificando que las emisiones de salida del motor cumplen con las regulaciones de emisiones aplicables de EPA de EE, UU, siempre que se sigan los procedimientos de mantenimiento aprobados según se indican en la sección de mantenimiento de este manual.

**OPERACIÓN PRELIMINAR Page 20**

**COMBUSTIBLE**

**Aceite de dos tiempos** - Se debe usar un aceite de motor de dos tiempos que cumpla con las normas ISO-L-EGD (ISO/CD. 13738) y J.A.S.O. FC. El aceite de calidad Echo 50:1 cumple con estas normas. Los problemas del motor debidos a una lubricación inadecuada por no usar un aceite certificado ISO-L-EGD y J.A.S.O.FC, tal como aceite de dos tiempos 50:1 de calidad óptima de Echo, anulará la garantía del motor de dos tiempos. (Las piezas relacionadas con las emisiones sólo están cubiertas durante dos años, sea cual sea el aceite de dos tiempos usado, según la declaración indicada en la explicación de garantía de defectos de emisiones de la Fase II de la EPA).

**MANTENIMIENTO Page 27**

**AJUSTE DEL CARBURADOR**

**NOTA**

Todas las unidades se hacen funcionar en fábrica y el carburador se ajusta en cumplimiento con las regulaciones de emisiones de EPA Fase II. Este carburador no tiene agujas de ajuste de aceleración y alta velocidad.